

# **PC104-550VL**

**PC/104 Embedded Vortex86™ CPU Module  
w/2S/CRT/LCD/Ethernet/onboard 64MB DRAM**

## **Quick Installation Guide**

**(Revision 1.0)**

## ● **Copyright**

The information in this manual is subject to change without notice for continuous improvement in the product. All rights are reserved. The manufacturer assumes no responsibility for any inaccuracies that may be contained in this document. And makes no commitment to update or to keep current the information contained in this manual.

No part of this manual may be reproduced, copied, translated or transmitted, in whole or in part, in any form or by any means without the prior written permission of the NAGASAKI IPC TECHNOLOGY

©Copyright 2002 NAGASAKI IPC TECHNOLOGY  
Manual No. ITQG6070000-01 ● June 12, 2002

## ● **Trademarks Acknowledgment**

Vortex86™ is the registered trademark of NAGASAKI IPC TECHNOLOGY

Other brand names or product names appearing in this document are the properties and registered trademarks of their respective owners. All names mentioned herewith are served for identification purpose only.

# Table of Contents

## **S e c t i o n 0 Startup**

0.1 Packing List .....	1
0.2 Specification .....	2

## **S e c t i o n 1 Installation**

1.1 Board Outline .....	4
1.2 Connectors & Jumper Settings .....	5

## **W a r r a n t y .....15**

- This page is intentionally left blank.

# Section 0

## Startup

### 0.1 Packing List

Product Name	Function	Package
PC104-550VL	PC/104 Embedded Vortex86™ CPU Module	<ul style="list-style-type: none"><li>● PC104-550 PC/104 Embedded Vortex86™ CPU Module</li><li>● Manual &amp; Drivers CD x 1</li><li>● FDD cable x 1</li><li>● HDD cable x 1</li><li>● RS232 cable x 2</li><li>● I/O Bracket for Printer port x 1</li><li>● PS2 Y-cable for Keyboard and Mouse x 1</li></ul>

## 0.2 Specification

Features	PC104-550VL
Processor Chipset	(SiS) Vortex86 System-on-Chip CPU-166MHz Real Time Clock with Lithium Battery Backup
Bus Interface	ISA and PC/104 Standard Compliant
Memory	Onboard 64MB SDRAM
BIOS	AMI BIOS
Multi I/O Chip	<ul style="list-style-type: none"> <li>● Enhanced IDE interface</li> <li>● RS232 port x1</li> <li>● RS232/485 port x1</li> <li>● Parallel port x1</li> <li>● FDD interface x1</li> <li>● USB port x2 (optional)</li> </ul>
Video Display	<ul style="list-style-type: none"> <li>● AGP Rev.2.0 Compliant</li> <li>● Shared system memory area up to 128MB.</li> <li>● Resolution up to 1,920Cx1,440 true colors</li> <li>● CRT/LCD display</li> </ul>
LAN	<ul style="list-style-type: none"> <li>● Realtek 8100B single chip</li> <li>● Full-duplex transfer mode, doubles effective bandwidth 16KB RAM buffer</li> <li>● NE2000 compatible with built-in 16KB RAM buffer</li> <li>● Throughput 10/100Mbps</li> </ul>
Connectors	<ul style="list-style-type: none"> <li>● 2.0mm 44-pin box header for IDE</li> <li>● 2.0mm 10-pin box header for RS-232 x2</li> <li>● 2 pin header for RS-485</li> <li>● 2.0mm 26-pin box header for printer</li> <li>● 2.0mm 34-pin box header for FDD</li> <li>● 2.0mm 10-pin box header for USB</li> <li>● 2.0mm 10-pin box header for VGA</li> <li>● 2.0mm 8-pin box header for Ethernet</li> <li>● External 15-pin D-type female VGA connectpr</li> <li>● 44-pin box header for LCD connector</li> <li>● 5-pin box header for AT-Keybaord connector</li> <li>● 5-pin box header for PS/2 Mouse</li> <li>● One 32-pin socket for for DiskOnChip</li> </ul>

## 0.2 Specification ... continuation

Watchdog Timer	<ul style="list-style-type: none"><li>● Software Watchdog Timer</li><li>● Three 8254 Compatible Programmable 16-bit Counters. From 30.5<math>\mu</math>s to 512 seconds</li></ul>
DiskOnChip	One socket for DiskOnChip 8MB~256MB
Power Requirement	Single Voltage +5V @1.2 A
Board Weight	225g
Board Size	90mm X 96mm
Operating Temperature	-20°C ~ +60°C

# Section 1

## Installation

### 1.1 Board Outline

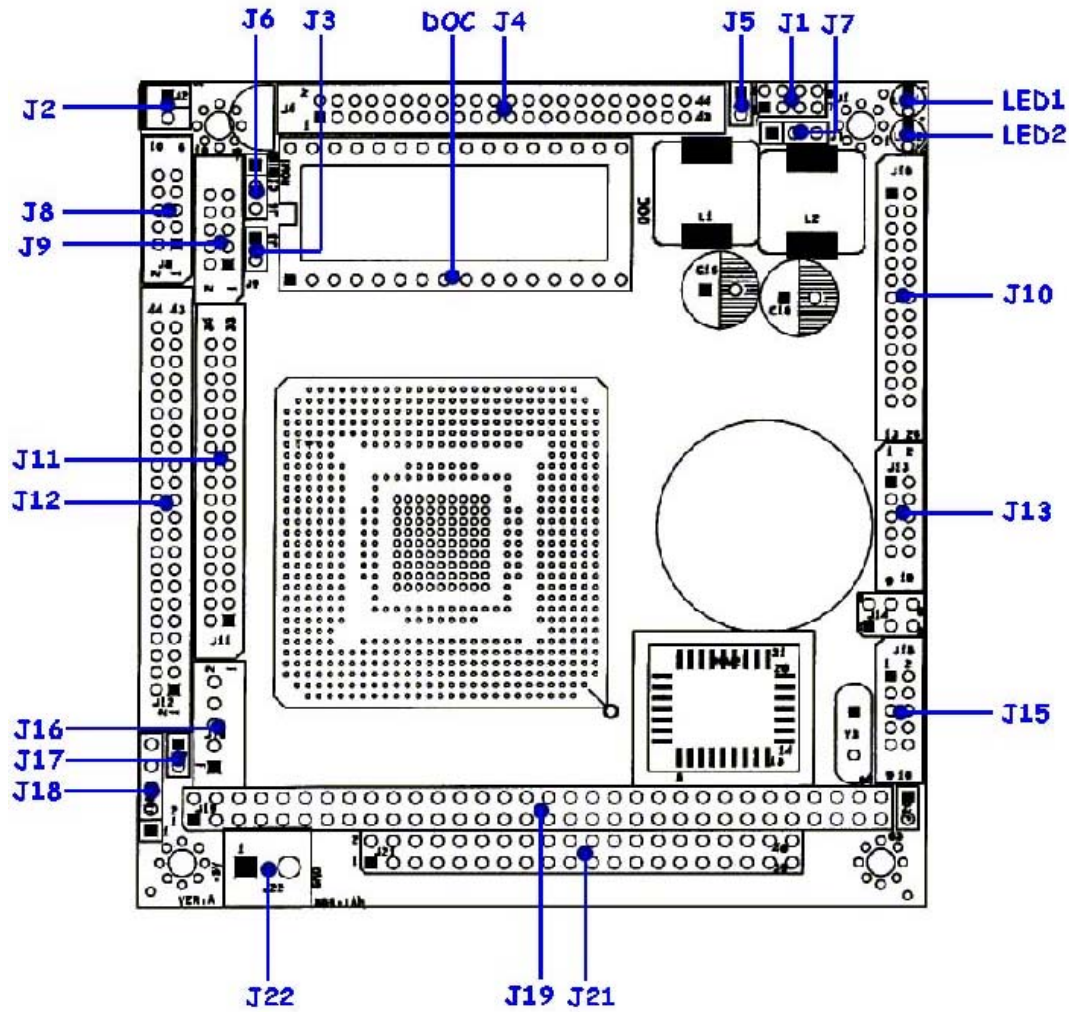

## 1.2 Connectors & Jumper Settings

### CONNECTORS & JUMPERS SETTINGS

J1:	LAN	Pin Header
J2:	RS485	Pin Header
J3:	RESET	Pin Header
J4:	IDE Connector	2.0 ØBox Header
J5:	IDE LED	Pin Header
J6:	LCD Volts Selection	Pin Header
J7:	RS232/485 Select	Pin Header
J8:	COM1	2.0 ØBox Header
J9:	COM2	2.0 ØBox Header
J10:	Printer Connector	2.0 ØBox Header
J11:	FDD Connector	2.0 ØBox Header
J12:	LCD Connector	2.0 ØBox Header
J13:	USB Connector	2.0 ØBox Header
J14:	Power Mode Sel.	Pin Header
J15:	VGA Connector	2.0 ØBox Header
J16:	PS/2 Keyboard	2.0 ØMolex Header
J17:	Speaker	Pin Header
J18:	PS/2 Mouse	Pin Header
J19,J21:	PC104 Connector	Box Header
J20	Power Button	Pin Header
J22:	Power Connector	Pin Header
ROM1:	DOC Connector (DiskOnChip)	Pin Header

### J15 :VGA Connector - 2.0 $\varnothing$ 10-pin Box Header

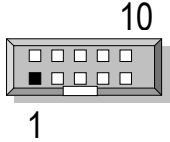
	Pin #	Signal Name	Pin #	Signal Name
	1	ROUT	2	GND
	3	GOUT	4	GND
	5	BOUT	6	GND
	7	HSYNC	8	GND
	9	VSYNC	10	GND

### J3: RESET - 2-pin Header

	Pin #	Signal Name
	1	PWROK
	2	GND

### J13: USB Connector - 2.0 $\varnothing$ pitch 10-pin Box Header

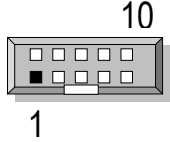
	Pin #	Signal Name	Pin #	Signal Name
	1	VCC	2	VCC
	3	-DATA1	4	-DATA0
	5	+DATA1	6	+DATA0
	7	GND	8	GND
	9	GND	10	GND

### J12: LCD Connector - 2.0 $\emptyset$ pitch 44-pin Box Header

Pin #	Signal Name		Pin #	Signal Name	
	Pin #	Signal Name		Pin #	Signal Name
1	LCDVCC	2	LCDVCC	2	LCDVCC
3	VAD0	4	VAD1	4	VAD1
5	VAD2	6	VAD3	6	VAD3
7	VAD4	8	VAD5	8	VAD5
9	VAD6	10	VAD7	10	VAD7
11	VAD8	12	VAD9	12	VAD9
13	VAD10	14	VAD11	14	VAD11
15	GND	16	UD4	16	UD4
17	UD5	18	UD6	18	UD6
19	UD7	20	GND	20	GND
21	VBD0	22	VBD1	22	VBD1
23	VBD2	24	VBD3	24	VBD3
25	VBD4	26	VBD5	26	VBD5
27	VBD6	28	VBD7	28	VBD7
29	VBD8	30	VBD9	30	VBD9
31	VBD10	32	VBD11	32	VBD11
33	GND	34	GND	34	GND
35	PLDXCLK	36	VBGCLK	36	VBGCLK
37	VADE	38	VBDE	38	VBDE
39	AHSYNC	40	VBHSYNC	40	VBHSYNC
41	AVSYNC	42	VBVSYNC	42	VBVSYNC
43	DISPOFF	44	VDDEN	44	VDDEN

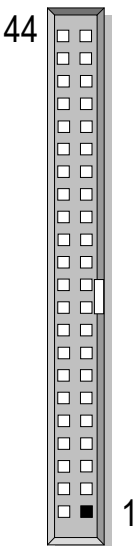

### J6: LCD Volts Selection - 3-pin Header

Pin #	Signal Name
1	VCC
2	LCDVCC
3	VCC3

### J17: Speaker - 2-pin Header

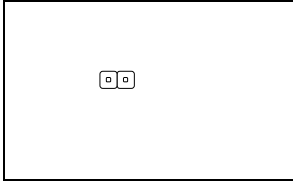
	Pin #	Signal Name
	1	SPKR
	2	VCC

### J20: Power Button - 2-pin Header

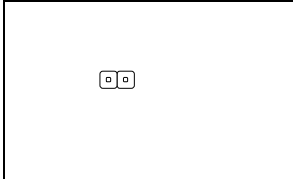
	Pin #	Signal Name
	1	PWRBIN-
	2	GND

### J16 : PS/2 Keyboard - 5-pin Molex Header

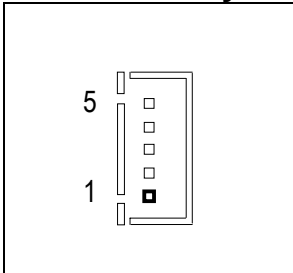
	Pin #	Signal Name
	1	KBCLK
	2	KBDAT
	3	NC
	4	GND
5	SB 5V (VCC)	

### J18 : PS/2 Mouse - 5-pin Header

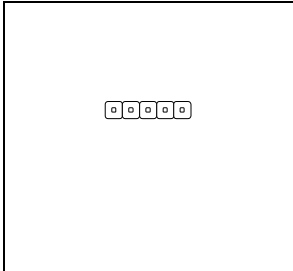
	Pin #	Signal Name
	1	PMCLK
	2	PMDAT
	3	NC
	4	GND
5	SB 5V (VCC)	

### J1 : LAN - 8-pin Header

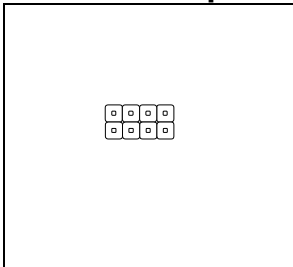
	Pin #	Signal Name	Pin #	Signal Name
	1	TX+	2	TX-
	3	RX+	4	CT/CMT
	5	CT/CMT	6	RX-
	7	CT/CMT	8	CT/CMT

### J4: IDE Connector - 2.0 $\varnothing$ pitch 44-pin Box Header

Pin #	Signal Name	Pin #	Signal Name
1	IDERST-	2	GND
3	IDED7	4	IDED8
5	IDED6	6	IDED9
7	IDED5	8	IDED10
9	IDED4	10	IDED11
11	IDED3	12	IDED12
13	IDED2	14	IDED13
15	IDED1	16	IDED14
17	IDED0	18	IDED15
19	GND	20	NC
21	IDEREQ	22	GND
23	IDEIOW-	24	GND
25	IDEIOR-	26	GND
27	ICHRDY	28	GND
29	IDACK-	30	GND
31	IDEIRQ	32	NC
33	IDESA1	34	CBLID
35	IDESA0	36	IDESA2
37	IDECS-0	38	IDECS-1
39	DASP	40	GND
41	VCC	42	VCC
43	GND	44	NC

### J5: IDE LED - 2-pin Header

Pin #	Signal Name
1	VCC
2	DASP

## ROM 1 (DiskOnChip) : DOC Connector – 32-pin Grid hole DIP Socket

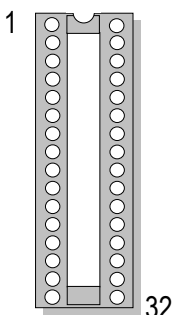
	Pin #	Signal Name	Pin #	Signal Name
	1	NC	2	NC
	3	NC	4	XA12
	5	XA7	6	XA6
	7	XA5	8	XA4
	9	XA3	10	XA2
	11	XA1	12	XA0
	13	XD0	14	XD1
	15	XD2	16	GND
	17	XD3	18	XD4
	19	XD5	20	XD6
	21	XD7	22	ROMCS1
	23	XA1	24	MDRCL
	25	XA11	26	XA9
	27	XA8	28	NC
	29	NC	30	NC
31	MWTCL	32	VCC	

## J14: Power Mode Sel. - 6-pin Header

	Pin #	Signal Name
	NC	ATX POWER (5V/SB5V)
	1-2	SINGL 5V
	2-3	SINGLE 5V ACPI

## J22: Power Connector - 2-pin Header

	Pin #	Signal Name
	1	SB5V
	2	GND

**J11 : FDD Connector - 2.0  $\varnothing$  34-pin Box Header (17x2)**

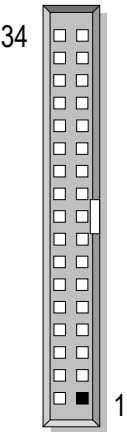
	Pin #	Signal Name	Pin #	Signal Name
	1	GND	2	DENSEL
	3	GND	4	NC
	5	GND	6	NC
	7	GND	8	INDEX\
	9	GND	10	MTR0\
	11	GND	12	DS1\
	13	GND	14	DS0\
	15	GND	16	MTR1\
	17	GND	18	DIR\
	19	GND	20	STEP\
	21	GND	22	WD\
	23	GND	24	WG\
	25	GND	26	TR0\
	27	GND	28	WP\
	29	GND	30	RD\
	31	GND	32	HDSEL\
33	GND	34	DSKCHG\	

**J7: RS232/RS485 Select - 3-pin Header**

	Pin #	Signal Name
	1-2	COM2 RS232
	2-3	RS485

**J2: RS485 - 2.54  $\varnothing$  2-pin Molex Header**

	Pin #	Signal Name
	1	RS485+
	2	RS485-

**J8 : COM1 (RS-232 Connector) - 2.0  $\varnothing$  10-pin Box Header**

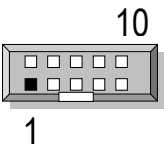
	Pin #	Signal Name	Pin #	Signal Name
	1	DCD1	2	RXD1
	3	TXD1	4	DTR1
	5	GND	6	DSR1
	7	RTS1	8	CTS1
	9	RI1	10	NC

**J9 : COM2 (RS-232 Connector) - 2.0  $\varnothing$  10-pin Box Header**

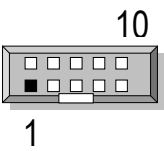
	Pin #	Signal Name	Pin #	Signal Name
	1	DCD2	2	RXD2
	3	TXD2	4	DTR2
	5	GND	6	DSR2
	7	RTS2	8	CTS2
	9	RI2	10	NC

**J10 : Printer Connector - 2.0  $\varnothing$  26-pin Box Header**

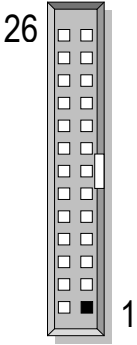
	Pin #	Signal Name	Pin #	Signal Name
	1	STB-	2	PD0
	3	PD1	4	PD2
	5	PD3	6	PD4
	7	PD5	8	PD6
	9	PD7	10	ACK-
	11	BISY	12	PE
	13	SLCT	14	AFD-
	15	ERR-	16	PRINIT-
	17	SLIN-	18	GND
	19	GND	20	GND
	21	GND	22	GND
	23	GND	24	GND
	25	GND	26	NC

## J19: PC/104 Connector - 64-pin Header Connector (CN1)

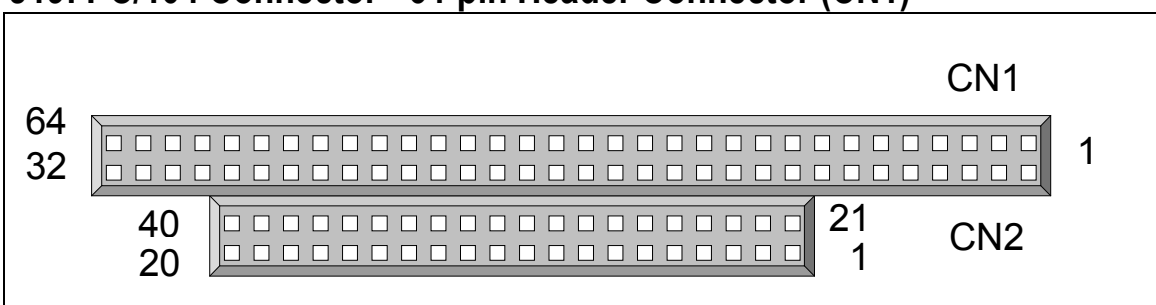

1	IOCHCHK *	2	GND
3	SD7	4	RESETDRV
5	SD6	6	+5V
7	SD5	8	IRQ9
9	SD4	10	-5V
11	SD3	12	DRQ2
13	SD2	14	-12V
15	SD1	16	ENDXFR *
17	SD0	18	+12V
19	IOCHRDY	20	(KEY)
21	AEN	22	SMEMW *
23	SA19	24	SMEMR *
25	SA18	26	IOW *
27	SA17	28	IOR *
29	SA16	30	DACK3 *
31	SA15	32	DRQ3
33	SA14	34	DACK1 *
35	SA13	36	DRQ1
37	SA12	38	REFRESH *
39	SA11	40	SYSCLK
41	SA10	42	IRQ7
43	SA9	44	IRQ6
45	SA8	46	IRQ5
47	SA7	48	IRQ4
49	SA6	50	IRQ3
51	SA5	52	DACK2 *
53	SA4	54	TC
55	SA3	56	SALE
57	SA2	58	+5V
59	SA1	60	OSC
61	SA0	62	GND
63	GND	64	GND

## J21 PC/104 Connector - 40pin Header Connector (CN2)

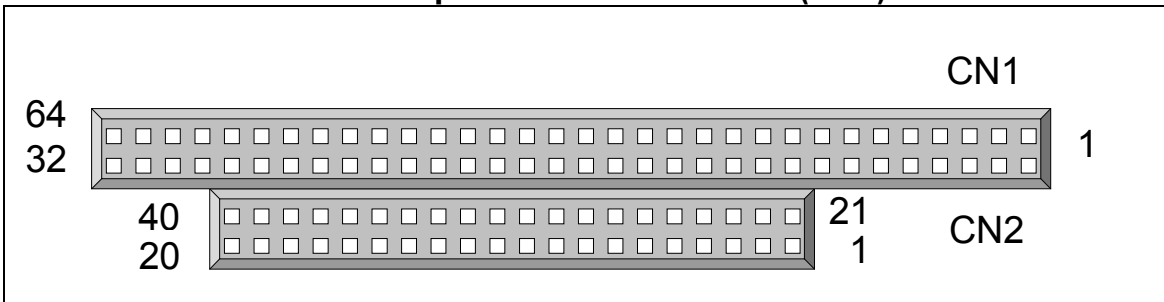

1	GND	2	GND
3	MEMCS16 *	4	SBHE *
5	IOCS16 *	6	LA23
7	IRQ10	8	LA22
9	IRQ11	10	LA21
11	IRQ12	12	LA20
13	IRQ15	14	LA19
15	IRQ14	16	LA18
17	DACK0 *	18	LA17
19	DRQ0	20	MEMR *
21	DACK5 *	22	MEMW *
23	DRQ5	24	SD8
25	DACK6 *	26	SD9
27	DRQ6	28	SD10
29	DACK7 *	30	SD11
31	DRQ7	32	SD12
33	+5V	34	SD13
35	MASTER *	36	SD14
37	GND	38	SD15
39	GND	40	(KEY)

# Warranty

This product is warranted to be in good working order for a period of one year from the date of purchase. Should this product fail to be in good working order at any time during this period, we will, at our option, replace or repair it at no additional charge except as set forth in the following terms. This warranty does not apply to products damaged by misuse, modifications, accident or disaster. Vendor assumes no liability for any damages, lost profits, lost savings or any other incidental or consequential damage resulting from the use, misuse of, origin to use this product. Vendor will not be liable for any claim made by any other related party. Return authorization must be obtained from the vendor before returned merchandise will be accepted. Authorization can be obtained by calling or faxing the vendor and requesting a Return Merchandise Authorization (RMA) number. Returned goods should always be accompanied by a clear problem description.